

## PR-E 3 -SMA

### Super Low Noise Preamplifier



- Datasheet -

#### Features:

- **Low Voltage Noise (0.6nV/ $\sqrt{\text{Hz}}$ , @ 1MHz single channel mode)**
- **Low Current Noise (12fA/ $\sqrt{\text{Hz}}$  @ 10kHz)**
- **f = 0.5kHz to 4MHz, A = 250V/V (customizable)**
- **Small Size**
- **Single or Dual Channel Device with SMA Terminals**

V 3.12, Feb. 2024

## Introduction

The PR-E 3 - SMA is a highly sensitive voltage preamplifier, which is intended for low-noise and high-impedance applications like FT-ICR cells, Schottky pickups or charge detectors. It is available as single or dual channel version. The dual-channel version can also be used in single-channel configuration, in order to lower further down voltage noise. The frequency range comprises 0.5 kHz to 4MHz (customizable), at a nominal voltage amplification factor of 250 V/V (high-Z load), or 125 V/V at 50Ω load respectively.

The small size makes upgrade of existing systems easy, improving sensitivity and delivering a better signal-to-noise ratio. The PR-E 3 - SMA is implemented as solid box of an aluminium alloy with gold plated input/output SMA terminals, offering very high immunity to external noise interference.

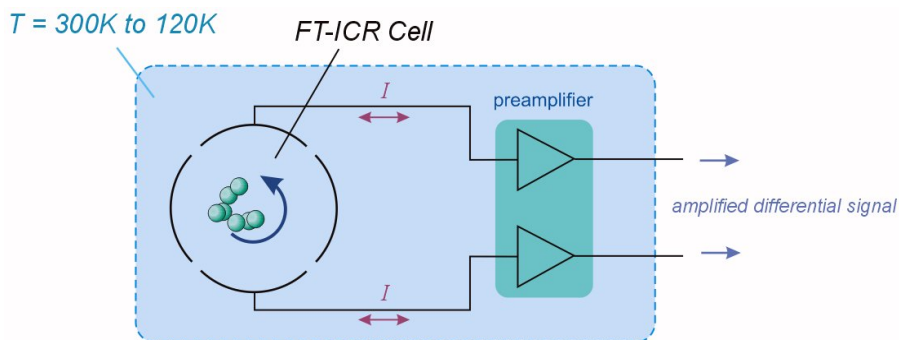

Fig. 1a: Typical Application: Differential Signal Detection in FT-ICR Cells

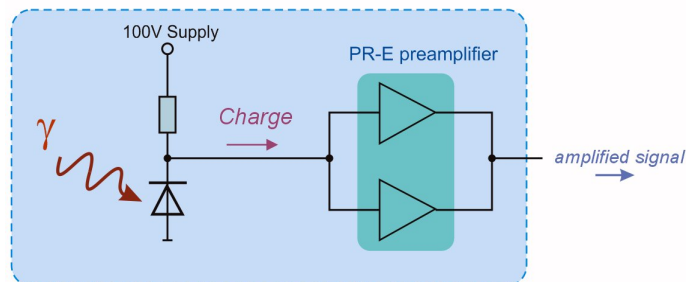

Fig. 1b: Photon Counting Application with Avalanche Photo Detectors, diagram shows channels connected

## Top/Side Views

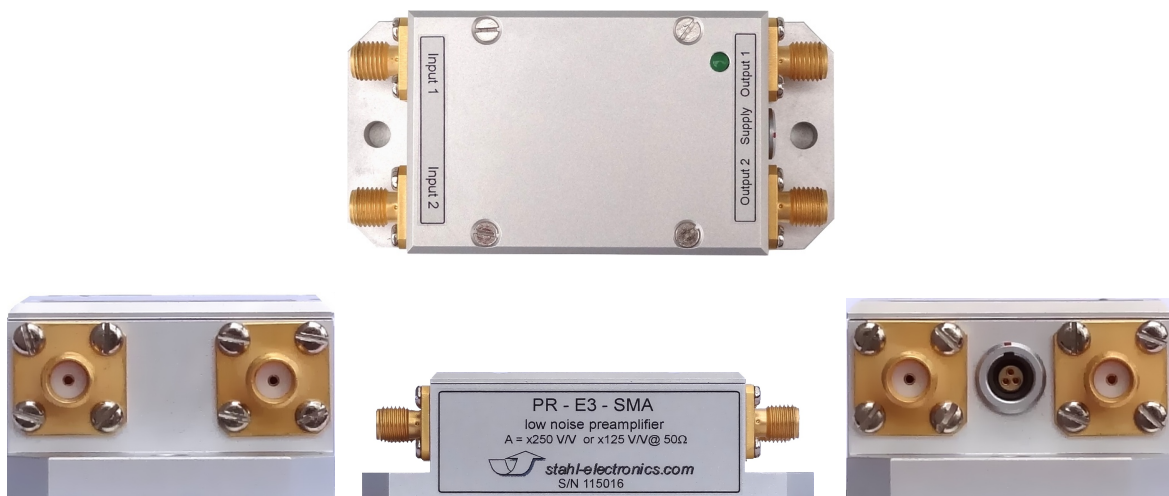

Fig. 2: 2-channel version top view, front view (inputs), side view and rear view (outputs and voltage supply)

## Functional Description

The following diagram illustrates the internal structure. This preamplifier consists of one or two independent paths, being supplied with common supply voltages. The input stages are formed by pre-selected low noise FET transistors, followed by amplification and buffer circuitry. Independent feedback loops guarantee a well balanced biasing point, also at low temperatures in a cooled operation.

Inside the two channel version the internal structure is symmetrical, so at either input or both inputs together (e.g. with opposite sign), ac input signals may be applied. The main target application is the amplification of intrinsically differential signals, like coming from FT-ICR cells (see also Fig. 1). Nevertheless amplification of non-symmetrical signals (like photo detectors or pickup electrodes) is possible as well. The input signal will appear after amplification on the corresponding output with opposite polarity (i.e. 180° phase shifted) with respect to the input, providing improved stability compared to non-inverting designs.

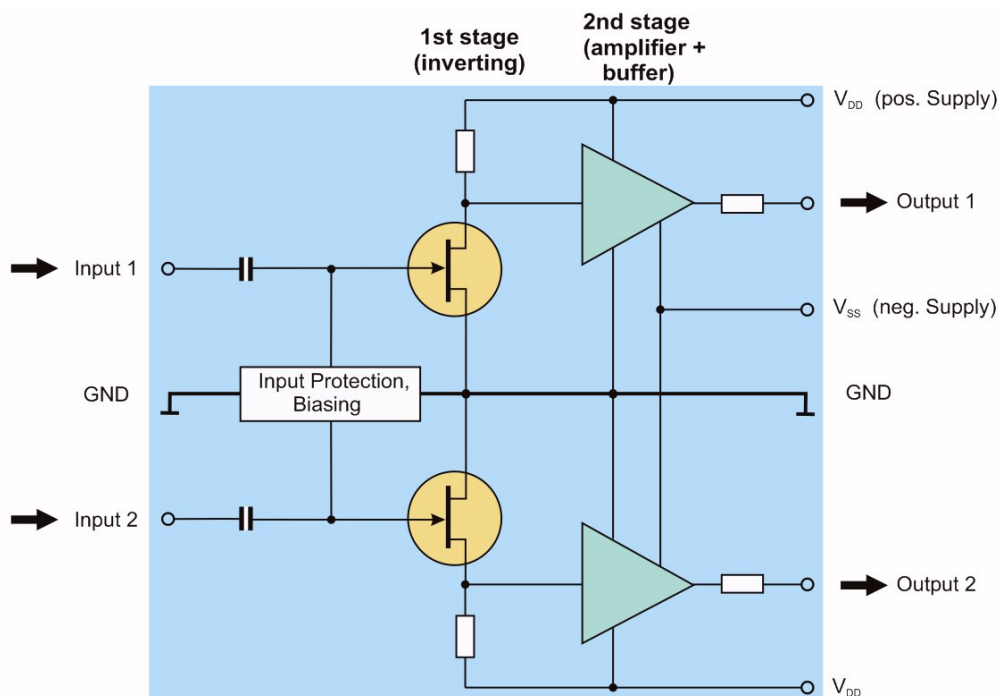

Fig. 3: Simplified Diagram of Internal Structure

Both inputs may also be connected together (see figure 1b, figure 16) to achieve even smaller input voltage noise (factor of  $\sqrt{2}$ ) at expense of higher input current noise ( $\sqrt{2}$  higher). This circuit scheme having both channels connected is subsequently referred to as “**single channel mode**”, whereas the individual use of the two channels is denominated as “**dual channel mode**”. These definitions refer to the two-channel version.

## Mains Supply and Connections

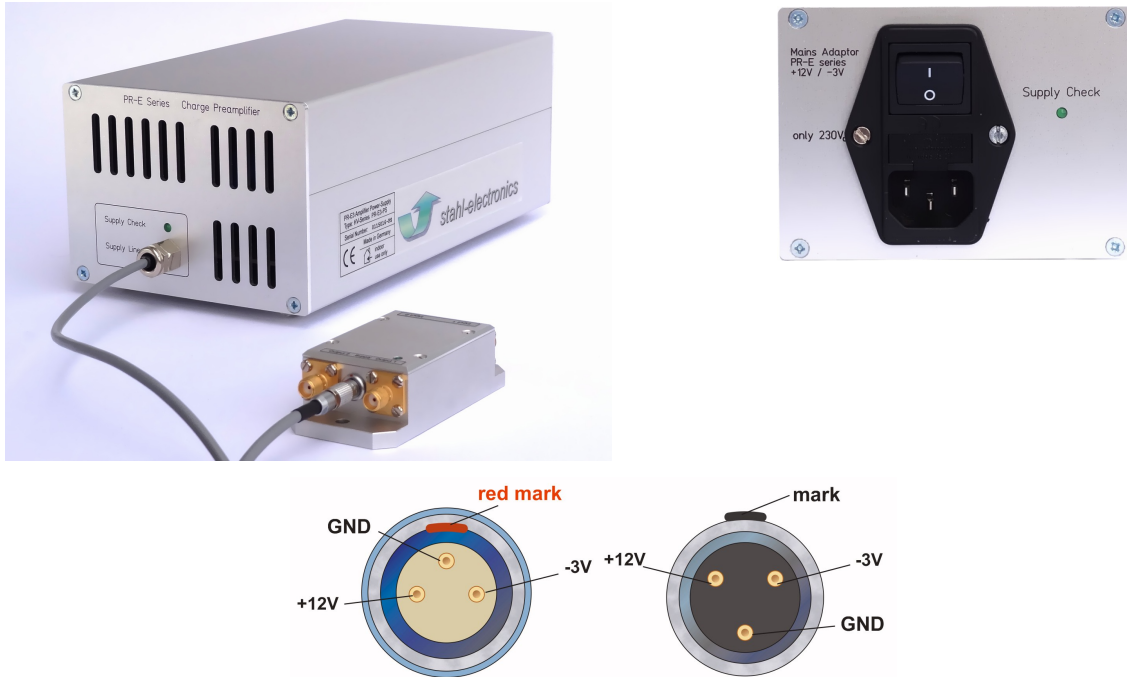

Fig. 4: Mains Supply, connection to amplifier module  
 left: Mains supply and PRE-3- module connected, upper right: rear side of mains adapter,  
 below: low voltage connector - view on PR-E case from outside, left: Lemo-type, right: Mini-XLR

The mains supply requires 230V<sub>ac</sub> supply voltage, 50Hz nominally. It should be connected with a standard IEC power cord to the power grid. Connection to the PR-E 3 - SMA module is established by a 3-pole connector cable with Lemo or Mini-XLR (ITT-Canon) connectors. Pinout is shown above. Note that devices with production date Feb. 2021 and later feature a shield GND switch, which allows for connecting the PR-E case GND and supply cable shield to the mains GND of the suppl, in favor of avoidance of external RF noise intrusion.

### Absolute Maximum Ratings

**Note:** Stresses above these ratings may cause permanent damage or degradation of device performance. Exposure to absolute maximum conditions for extended periods may also degrade device parameters or reliability.

Parameter	min.	max.	
pos. Supply Voltage $V_{DD}$	-0.3V	+12V	avoid connecting the voltage supply lines with wrong polarity.
neg. Supply Voltage $V_{SS}$	+0.3V	-5.5V	
$V_{DD} - V_{SS}$		15V	
Input Voltage absolute value (AC+DC)		25 V <sub>pk</sub> vs. GND,	derating inversely proportional with frequency above 5MHz
AC		5V <sub>pp</sub> , f = 0 ... 5MHz	
DC		350V	
Admissible Input Current (see remarks)		40 mA <sub>eff</sub>	permanent current through protection circuitry
		1A <sub>pk</sub>	maximum peak current for less than 10ms, at max. 1 Hz repetition rate
Output Voltage	0V	+5V	under normal conditions no voltage source must be applied to the outputs
Storage Temperature	-55°C	125°C	baking is possible up to 125°C, max. for 48 hours

Table 1: Absolute Maximum Ratings

### Typical Operating Parameters, unless customized

Parameter	typical Value	Remarks/Conditions
Standard Freq. Range @ 300K for $\pm 3$ dB deviation (customizable on request) upper frequency limit, 10dB dev.	0.5 kHz or 1.5 kHz....4.0 MHz  10 MHz	medium impedance load, $C_{Load} < 125$ pF
Gain  Voltage gain @300K  amplification factor mismatch between both channels (two-channel version)	$\times 250 \pm 4\%$  typ. $\pm 1.5\%$ max. $\pm 3.5\%$	Medium to high impedance load, $C_{Load} < 125$ pF, $f = 100$ kHz  @ $f = 2$ kHz...200kHz
Input Impedance at either input DC  AC resistive impedance and input capacitance vs. GND	$> 300$ M $\Omega$  150 M $\Omega$ , capacitively coupled 16.4pF $\pm 2.0$ pF	@ 300K  $f \leq 100$ kHz
Output Impedance  @ 300 K Output Power	50 $\Omega$ vs. GND  max. 5mW	@ $f = 2$ kHz ... 250kHz
Input Noise <i>noise figure per channel</i>  voltage noise density current noise density  <i>both channels connected</i>  voltage noise density current noise density	1.05nV / $\sqrt{\text{Hz}}$ 12 fA / $\sqrt{\text{Hz}}$  0.69nV / $\sqrt{\text{Hz}}$ 22 fA / $\sqrt{\text{Hz}}$	@ $f = 100$ kHz, T = 300K @ $f = 10$ kHz, T = 300K $V_{DD} = 12$ V  @ $f = 100$ kHz, T = 300K @ $f = 10$ kHz, T = 300K $V_{DD} = 12$ V T = 300K
Equivalent Noise Charge <i>each channel</i>	245 $e^-_{rms}$ @ $C_{DET} = 10$ pF 301 $e^-_{rms}$ @ $C_{DET} = 100$ pF (rms = root mean square)	Pulse shaping circuit see figure 18 $\tau_{HP} = 27\mu\text{s}$ (high pass), $\tau_{shape} = 2\mu\text{s}$
Operating voltages $V_{DD}$ , positive supply voltage $V_{SS}$ , negative supply voltage	+4.5V...+9V -2.4V...-5V	observe that $V_{DD}-V_{SS} < 12$ V in any case
Channel Crosstalk	$> 90$ dB @ 100kHz 75dB @ 1MHz	50 Ohm input/output loads; see figure 11
Maximum AC Output Voltage	3.8V <sub>pp</sub>	medium impedance load, $C_{Load} < 125$ pF @ $f = 1$ kHz...250kHz
Supply Currents typical values $V_{DD} = 12$ V $V_{SS} = -3.0$ V	12.5mA -2mA	details see figure 10
Operating Temperature	T = -55°C...60°C	
Magnetic Properties	Device consists mostly of non-magnetic materials. small amounts of ferromagnetic substances $< 1$ x gr. possible	For use with FT-ICR cells, it is recommended to locate the device min. 12cm away from the ion trap in order to avoid magnetic disturbance
Geometrical Size and Weight	88mm x 41.6mm x 26mm / 130 gr.	
<b>Mains Supply Unit</b> grid voltage	115V <sub>ac</sub> or 230V <sub>ac</sub> +/-10%, 50/60 Hz	Note that required grid voltage depends on country, the supply expects a defined voltage.
power consumption	max. 5W, typ. 2.6W	Fuse in mains supply filter: 100mA medium-slow (230V <sub>ac</sub> ) or 200mA medium-slow (115V <sub>ac</sub> )
Output voltage	Stabilized +12V and -3V (low noise)	Internal DC current limitation: 125mA

Table 2: Typical data

## AC connections and Grounding

*Grounding and Shielding* are general issues of concern, especially in connection with high-impedance charge or voltage amplifiers. A proper grounding and shielding geometry is essential to maintain good device performance and to achieve the low noise characteristics, described in the specifications. The typical RF-(radio-frequency) design rules for proper grounding and shielding apply here, even though the upper limit of the frequency range just barely reaches the HF (high frequency) regime. To ensure a “clean” environment, good ground connections around the amplifier have to be provided, avoiding ground loops, keeping lines as short as possible and of low inductance-style. All DC-lines leading to the signal source in front of the amplifier, e.g. a FT-ICR Ion Trap or Photo Detector, should be filtered appropriately by low pass filters. Failure in providing a good grounding, may lead to a considerably increased noise level and can cause in extreme cases self-oscillations of amplifiers.

Signal connections may be implemented as coaxial or twisted-pair lines, to avoid external interference and unwanted feedback from the output to the high-impedance input. The connections from the signal source to the PR-E input may also have a dedicated ground shield to minimize external noise pickup and should be as short as possible. A low-capacitance cable is preferable.

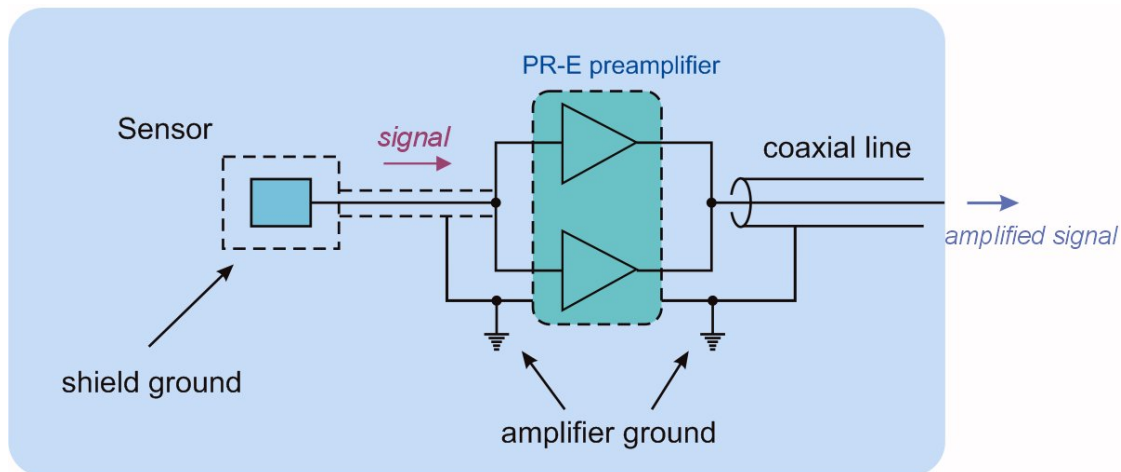

Fig.5: Example of shielding and ground line connections (connections shown for “single channel mode”, both channels connected). Distance between sensor and amplifier should be kept as short as possible for optimum signal-to-noise (S/N) ratio.

The GND-connection at the input of the amplifier (SMA shield) must be connected appropriately to the signal source, and the supply/output lines respectively. Especially a good low impedance ground is very important at the input. In noisy environments the output line also should be implemented as coaxial line. The rf-impedance of the output cabling is not critical, unless the cable length greatly exceeds ~2m. In that case the PR-E output resistance of 50 Ohms becomes relevant and a 50 Ohms-cable should be used.

### Input Circuitry

The subsequent figure shows the input protection circuitry for each input. DC blocking capacitors are provided in order to maintain a reasonable amount of admissible DC voltage being applied to the inputs. The maximum allowed DC voltage at input is  $\pm 350V_{DC}$ .

Even though this relatively high voltage may be applied (DC-wise), the limited pulse capability of maximum  $1A_{pk}$  for less than 10ms duration has to be kept in mind, which is restricted by the maximum possible current through antiparallel protection diodes (see fig. 6). This matters especially if the attached electrodes are run in a switched or pulsed mode, or exposed to radio frequency bursts.

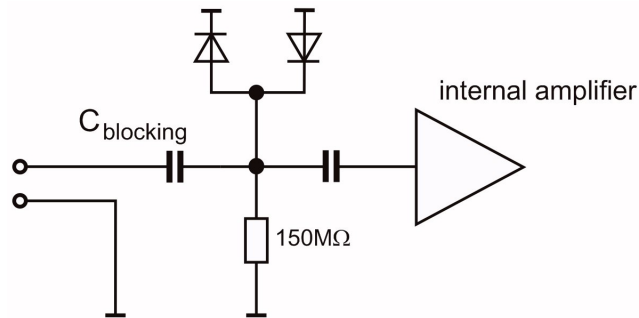

Fig. 6 : Input protection scheme (each channel)

After the blocking capacitors, the inputs feature each a 150MΩ resistor to the input GND. The ESD-protection diodes limit the maximum voltage at this point to about  $\pm 725mV$ .

Behind this protection circuitry the subsequent amplifier stages follow capacitively (AC) coupled.

### Output Circuitry

The subsequent figure shows the output configuration. ESD protection diodes provide a certain degree of protection against electrostatic discharge effects. The output impedance equals 50 Ohms nominally. Normally, in case the amplifier output is connected to subsequent signal processing circuitry (analog or digital), a 50 Ohms termination at the other end of the line is not required. In cases when cable length to the next stage exceeds 3m, a termination with 50 Ohms may help to keep the flatness of amplifiers over-all frequency response, finally at a cable length above 6m a termination is recommended to avoid unwanted cable reflections.

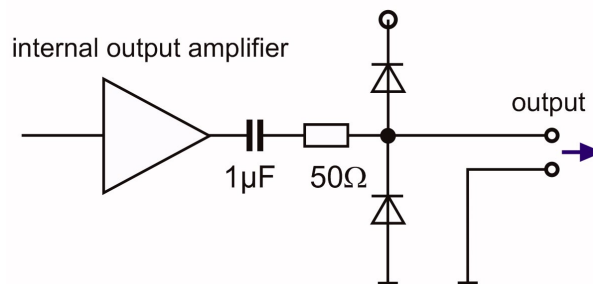

Fig. 7: Output circuit scheme (each channel)

In case a 50 Ohm resistive load is attached to the amplifier's output, the attenuation of signal amplitude by a factor of 2 should be kept in mind. For instance at a supply voltage of +12V/-3V (given by the manufacturer's mains supply) the nominal voltage amplification will be  $\times 125$  V/V with 50 Ohm termination, or  $\times 250$  V/V otherwise (high-Z or open-ended).

### ***Power Supply***

The PR-E amplifier can be supplied with the manufacturer's power supply or customized other supply voltages. It may be operated symmetrically (+/-5V) or in a non-symmetrical way. One may consider a non-symmetrical supply, e.g.  $V_{DD} = +9V$  and  $V_{SS} = -2.5V$ , to achieve some improvement in the obtainable signal to noise ratio (S/N), since the device's input noise slightly decreases (improves) with increasing positive voltage supply. This fact is also illustrated in figures 12 and 14. It should be ensured that a maximum voltage span of 15V between the positive and negative supply lines ( $V_{DD}$ ,  $V_{SS}$ ), is never exceeded.

The current consumption at the positive supply  $V_{DD}$  is typically around 12mA. Details are shown in figure 10. The current being drawn on the negative supply  $V_{SS}$  is in the order of 2mA. Power sequencing is not required, both positive and negative supplies may be switched on at the same time or after each other.

For optimum device performance the supply voltages should be well filtered. Normally a standard regulated voltage source with inexpensive type 78xx/79xx active components and a shielded supply cable to the PR-E amplifier will suffice.

The manufacturer's mains adapter delivers +12V and -3V as  $V_{DD}$ ,  $V_{SS}$  on a 3pole cable and feeds the PR-E 3 - SMA via a Lemo "type 0B" plug/socket, or Canon Mini-XLR connector (depending on PR-E version). When connecting the supply cable to the PR-E 3 - SMA please make sure that the red marks match on plug and socket. The plug can be detached by carefully pulling the handle ring. Due to the small size of the plug always apply great care and only gently pull/push the plug. Never pull the cable without unlocking the plug.

### ***Stability Issues***

Note that, as with any amplifier featuring a very high input impedance and high amplification factor at the same time, there can be stability issues (self-oscillation) in case reactances with large Q-factor are attached to the input. For instance, long cables (typ. > 2m length) with a resonator or high impedance signal source at the other cable end might be problematic. In case oscillations are being observed, an improvement of grounding and shielding often cures the issues, or in case the latter is not successful, a series resistor of a few Ohms (e.g. 10 $\Omega$ ) may be added at the input, to decrease the effective Q-factor by introducing ohmic dissipation.



## Typical Performance Characteristics

### Voltage Amplification Factor vs. Frequency

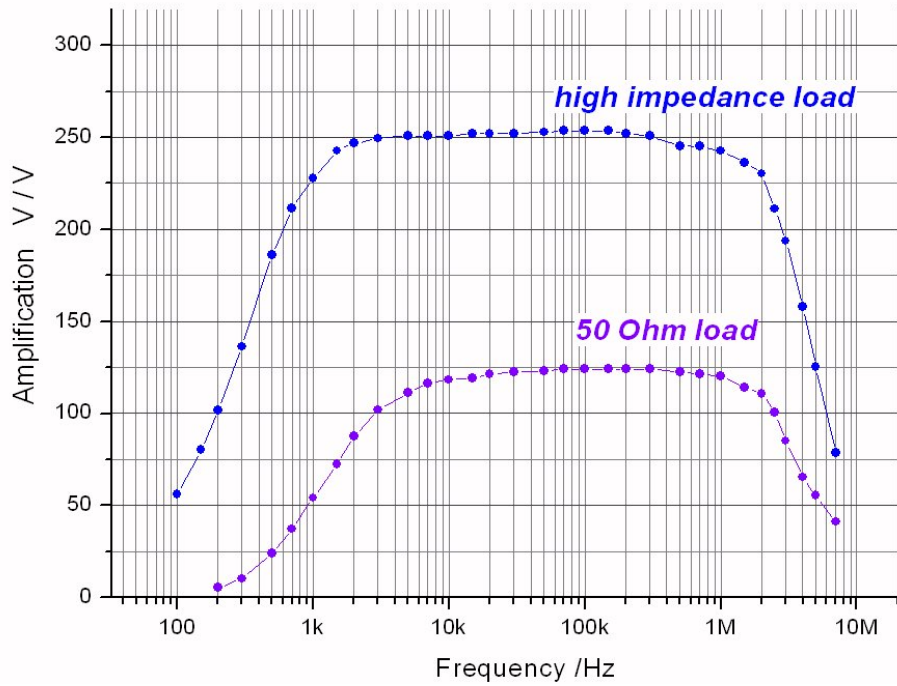

Fig. 8: Voltage Amplification Factor vs. Frequency, supply voltage: +12V/-3V, T = 297 K, with high impedance (1M $\Omega$ , 50pF) and 50 $\Omega$ -load

### Voltage Amplification vs. Positive Supply Voltage

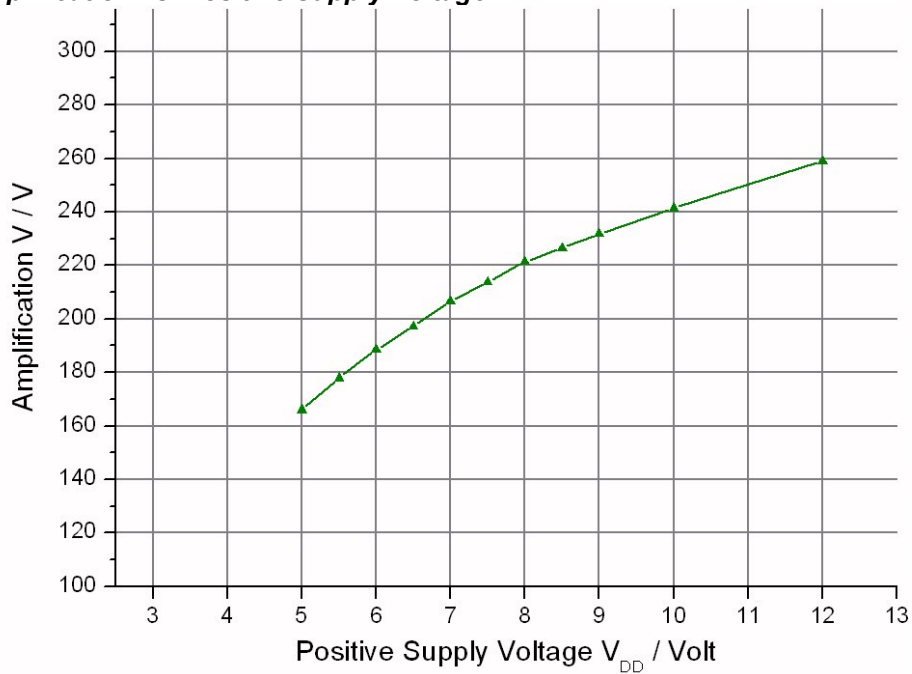

Fig. 9: Voltage Amplification Factor vs. positive supply voltage, f = 100kHz, while  $V_{SS} = -3V$  (fixed)

### Positive Supply Current vs. Positive Supply Voltage

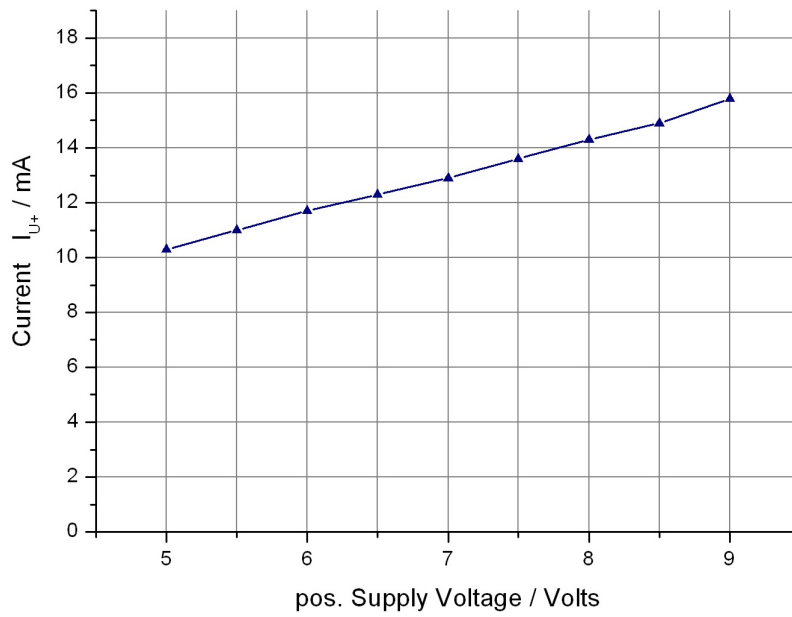

Fig. 10: Positive Supply Current vs. positive supply voltage  $V_{DD}$ , outputs not loaded,  $V_{SS} = -2.5V$  (fixed)

### Crosstalk between Channels

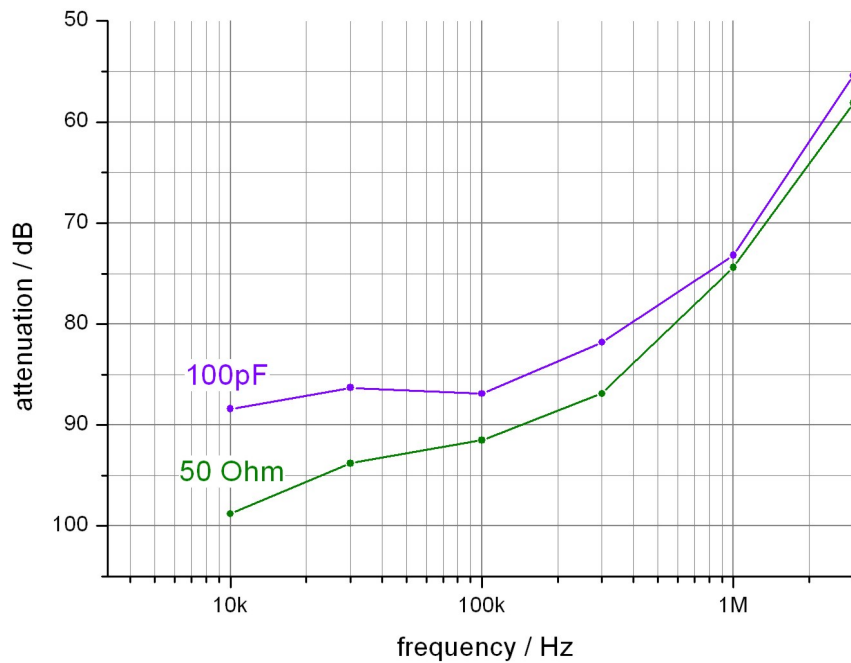

Fig. 11: Crosstalk between the two channels (dual channel mode) as function of frequency and input termination. Input termination upper curve: 100pF vs. GND, lower curve 50 Ohms vs. GND.

### Voltage Noise Density at Roomtemperature (Dual Channel Mode)

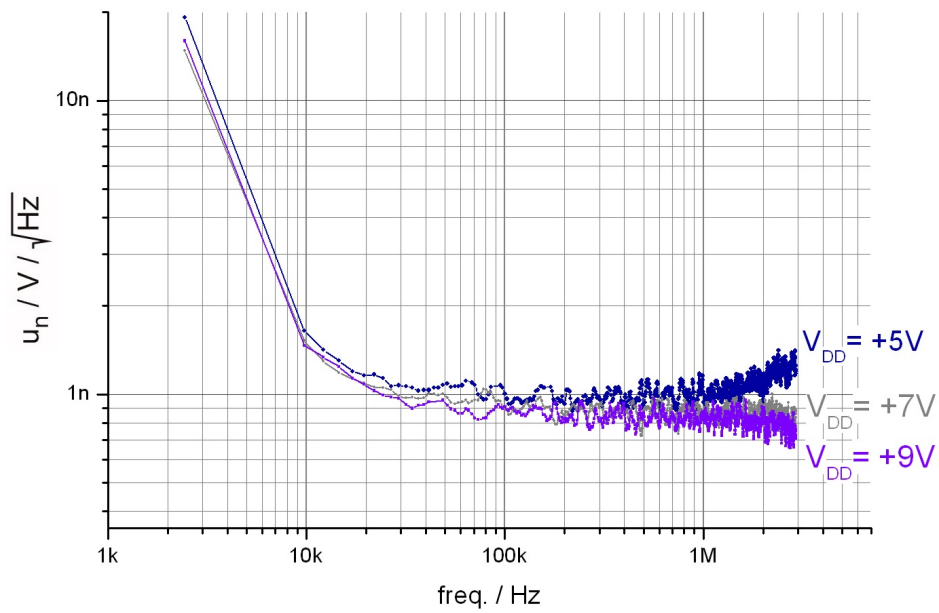

Fig. 12: Voltage Noise Density (one channel of two) at room temperature with different positive supply voltages.  $V_{SS} = -2.5V$ . If the provided mains supply (PR-E Supply) or version PRE-SMA is used, the lower trace is applicable

### Current Noise Density at Room Temperature (Dual Channel Mode)

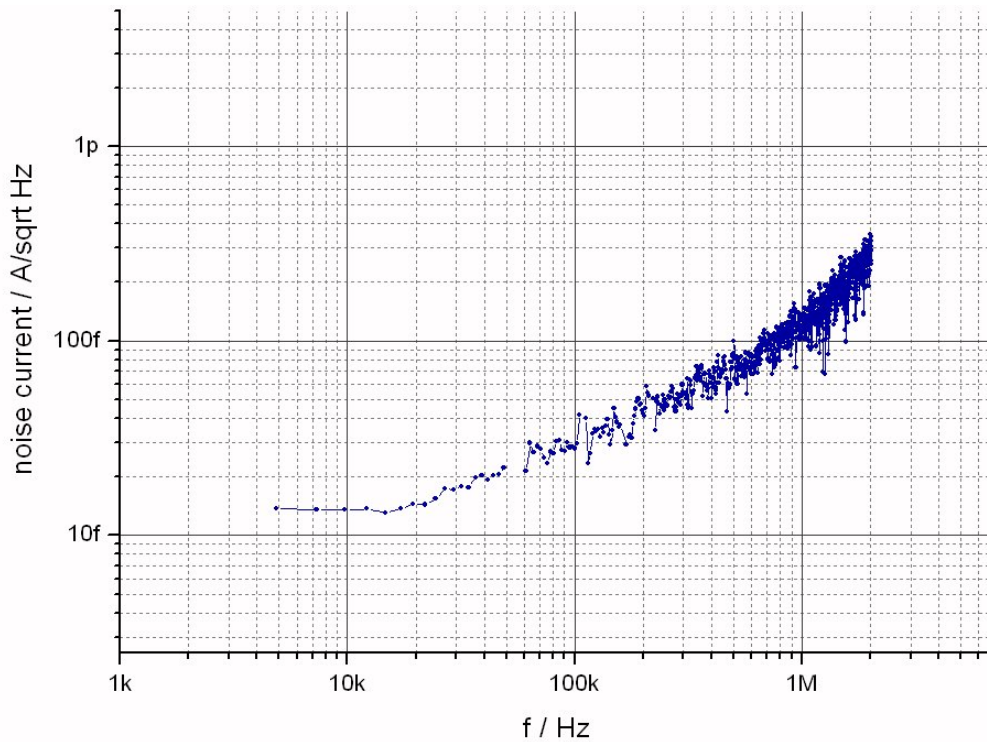

Fig. 13: Current Noise Density (one channel of two) at room temperature. Supply voltages are  $\pm 5V$ .

### Voltage Noise Density at Roomtemperature (Single Channel Mode)

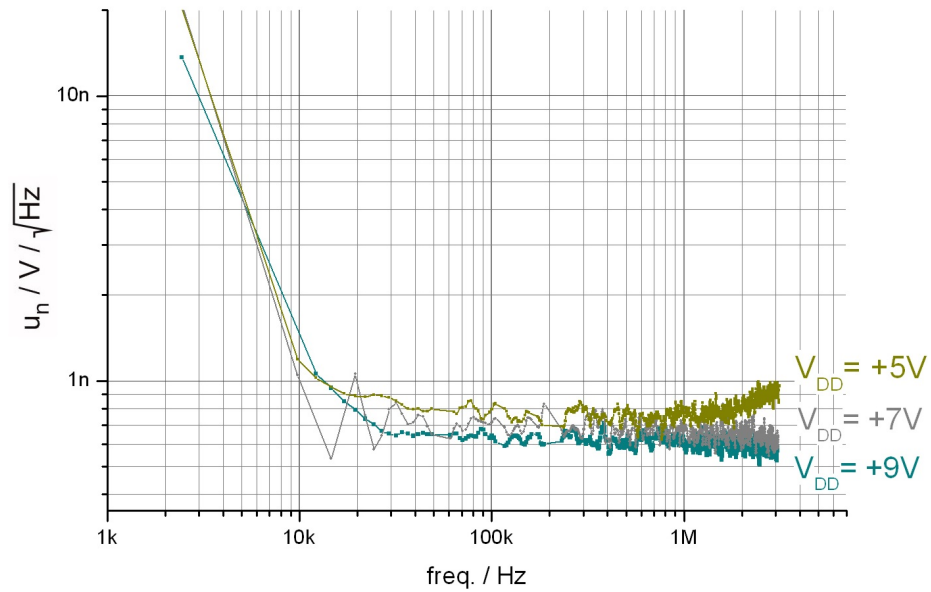

Fig. 14: Voltage Noise Density (two-channel version, both channels connected) at room temperature with different positive supply voltages.  $V_{SS} = -2.5V$ . If the provided mains supply (PR-E Supply) or version PRE-SMA is used, the lower trace is applicable.

### Current Noise Density at Room Temperature (Single Channel Mode)

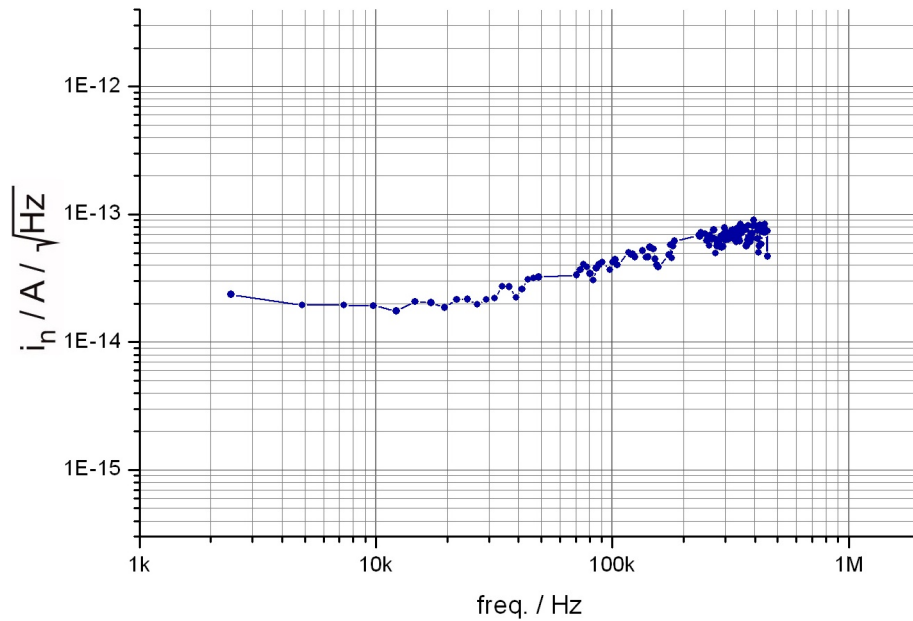

Fig. 15: Current Noise Density (both channels connected) at room temperature.

### Connection scheme for single channel mode

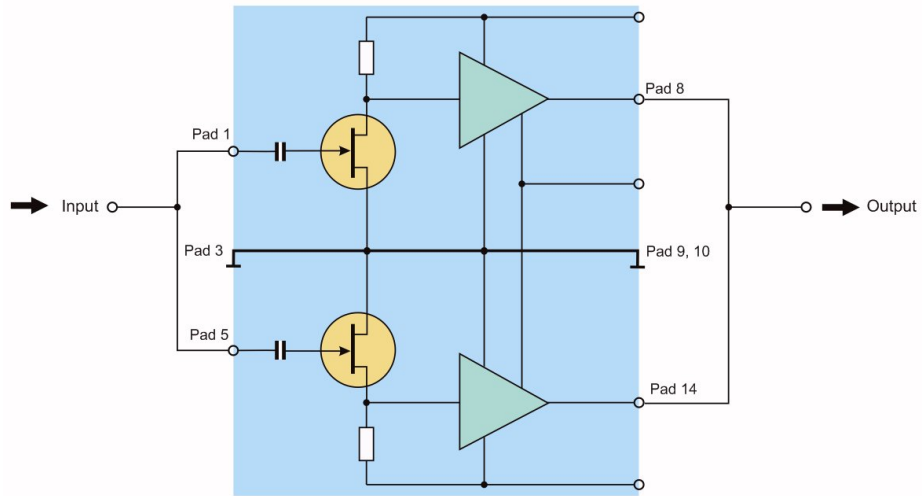

Fig. 16: Connection scheme for “single channel” operation, used to obtain data of figures 14 and 15.

### Noise Charge

Effective noise charge (rms-value) at input vs. detector capacitance

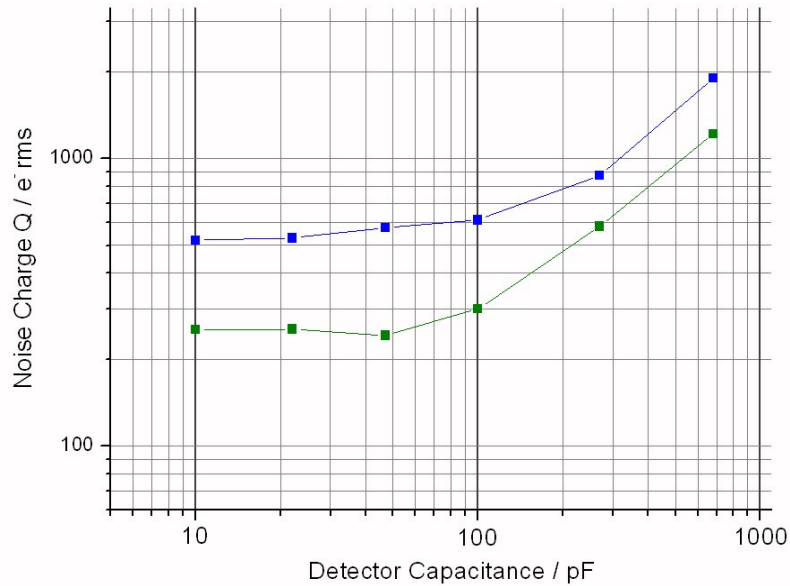

Fig. 17: Experimentally determined effective input noise charge  $Q$  in  $e_{rms}$ , as function of detector capacitance.

Upper curve:  $\tau_{HP} = 270\mu s$ , lower curve:  $\tau_{HP} = 27\mu s$ , both curves:  $\tau_{shape} = 2\mu s$ ; see also figure 18.

The graph refers to the dual channel mode (inputs not connected) and one single channel.

### Noise Charge Measurement Setup

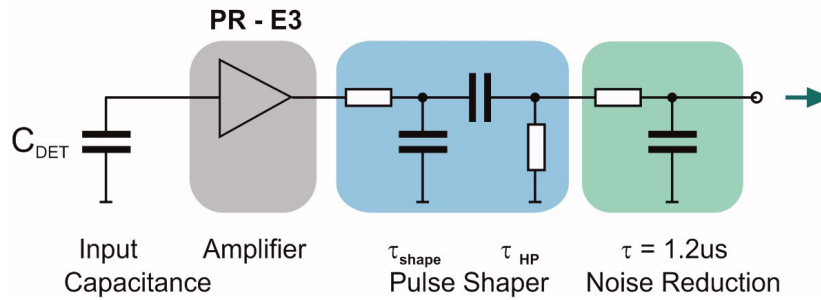

Fig. 18: Measurement setup for obtaining the diagram in figure 17. The effective noise charge at the input is recalculated from the measured rms-voltage at the output. A pulse shaper and noise reduction circuit is used to define the measurement conditions. The data in figure 17 are obtained with commonly used values for pulse shaping and input/detector capacitance. The detector capacitance is simulated by adding a NPO type capacitor to the input.

### Case Outline

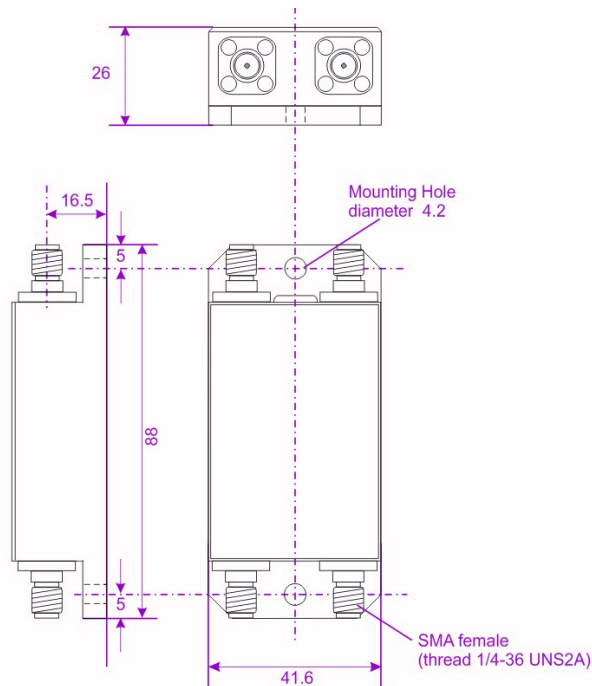
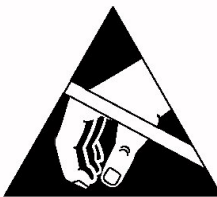

figure 19: housing outline dimensions (millimeter)

### Electrostatic Sensitivity



This device can be damaged by ESD (Electrostatic Discharge). It is strongly recommended to handle the device with appropriate precautions.

Failure to observe proper handling and installation procedures can easily cause serious damage. This ESD damage can range from subtle performance degradation to complete device failure.

© 2024 Stahl-Electronics

Contents may be changed without further notice.